



ELECTRICAL INFORMATION

Model No.	LXB300	LXB300
Power Consumption (±5%)	30W	50W
Power Supply	MeanWell	
Input Voltage	AC 100-277V	
Power Factor	>0.95	
Surge Protection	3.75KV	
Driver Type	Constant Current (CC)	
Control	DALI, 0-10V DIMMING AND EMERGENCY	



CE SAA



CB



RoHS

DESCRIPTION

The ENDURO LED bulkhead provides a large area of bright and widely scattered light, built to withstand corrosion, heat and voltage surges and with various installation options, making it an ideal choice for applications such as tunnel, mining, industrial, logistical warehouse and ambient spaces.

KEY FEATURES

- High efficacy 155 lm/w
- Ultra wide angle illumination
- Various mounting options
- Suitable for various applications
- Anticorrosion, voltage, water and heat tested
- IP66

APPLICATIONS

- Tunnel
- Warehouse
- Logistical Facilities
- Mining
- Ambient Space

OPTIC INFORMATION

LED Type	3030 SMD	
Luminous Flux (±10%)	4650lm	7750lm
Efficacy (5000K Ra70)	155lm/w	
Correlated Colour Temperature	5000K (Other CCT Available)	
Colour Rendering Index	Ra >70 (Ra >80 available)	
Beam Angle	Asymmetric 150°	

DIMENSIONS AND MOUNT

Product DIMENSIONS	280mm*160mm*140mm	
Luminaire Net Weight	1.15kg	1.2kg
Export Carton Size	820mm*305mm*320mm (10 pieces)	
Gross Weight	14.5kg	15kg
Mounting Option	Ceiling, Suspension, Wall	
Material	Aluminium Pc	
Finish	Powder Coat	
Fixture Colour	Black	
EPA	NA	
IK Rating	IK10	
IP Rating	IP66	

LIFESPAN AND WARRANTY

Operating Temperature	-40°C - 60°C	
Life Time of LED @Ta=25°C	>100000hrs	
Warranty	5 Years	

NEW FEATURES

* Please consult us for details.		
----------------------------------	--	--

PHOTOMETRY

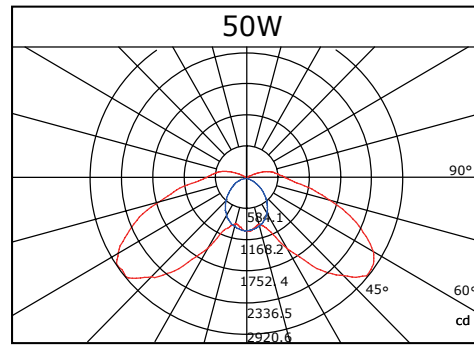
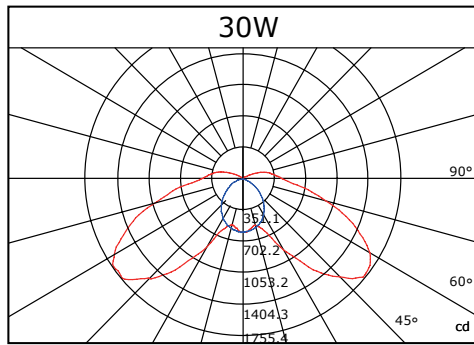

MOUNTING OPTIONS

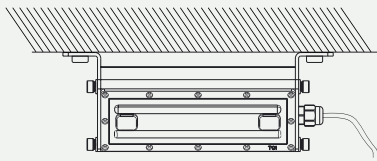

Ceiling Installation

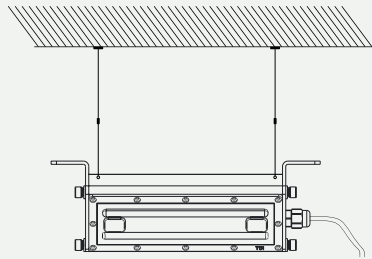

Suspension Installation

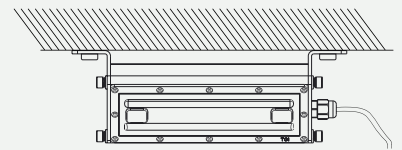

Wall Installation

DIMENSIONS

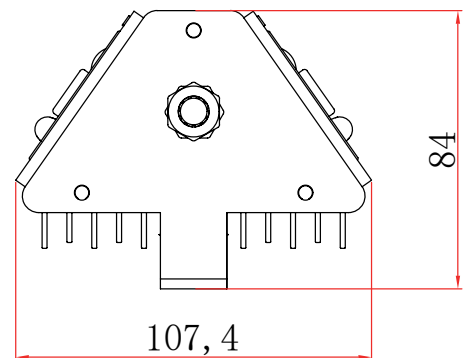
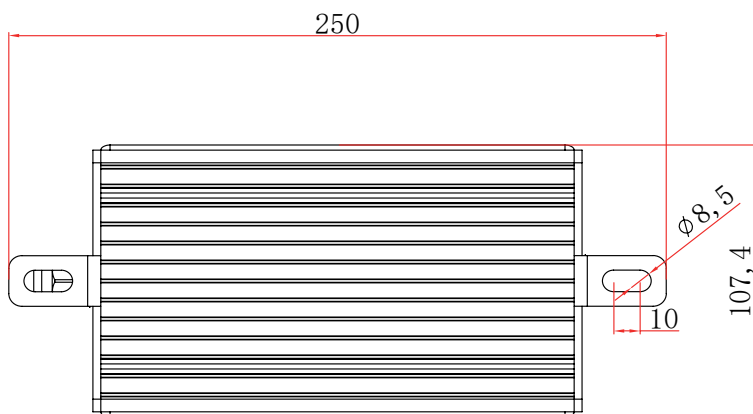

PRODUCT ORDERING CODES (LSL)

SERIES	POWER	CCT (K)	OPTICS	CONTROL	EMERGENCY	MOUNT	ACCESSORY	FINISH
LXB300	30W	5-5000	150°	DA (DALI)	E (EMERGENCY)	C (CEILING)	N/A	BLACK
	50W			D (0-10V DIMMING)		W (WALL)		
						S (SUSPENDED)		

Example ordering code for: 30w, 5k, 150°, dimmable, ceiling, black
 PRODUCT CODE: LXB300305150DCB
 PRODUCT NAME: ENDURO