

# LXTL5000

**SINGLE-PERSON  
OPERATED BATTERY  
PORTABLE LIGHT TOWER**



# ZERO

- NOISE
- EMISSIONS
- FUEL CONSUMPTION



0dB Quiet Operation



50Kg-Class Single-Person Rapid Deployment



0 Diesel Cost



Triple Wheel + Self-Locking Leg Adapts To All Terrains



0 Carbon Emissions



IP65 Weatherproof Wind Resistance Level 8



0 Maintenance Cost



Lithium Battery Powered Versatile For Various Sites



0 Trailer Cost



Fully Rotatable Head & Adjustable Beam Angle For Versatile Lighting Area

LXTL5000 cuts both equipment and life-cycle consumption / transportation / maintenance costs compared to the traditional fuel generator light tower.

**COST**



**MOS** (Months of service)



# High Elongation Ratio For Easy Storage And Transport

5.3m

4.2m

1.2m

1.3m



# Unique Cloud-Axis Electric Telescopic Pole

Original mechanical structure that maximises weight reduction while maintaining stability.

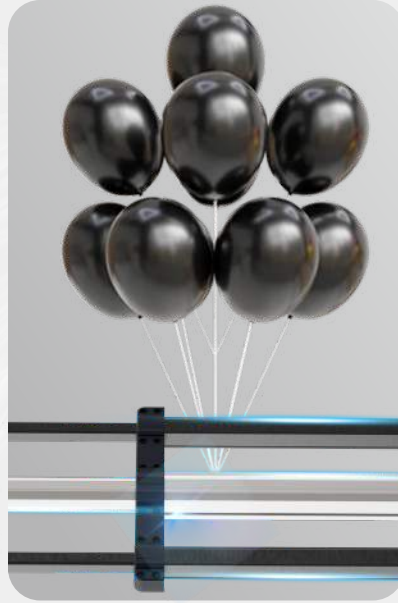

IP65, resistant to gale force winds L8, corrosion-resistant



# Each lamp head can be adjusted freely

Unidirectional  
Multi-Point Lighting



360° Lighting with  
Adjustable Coverage



180° rotation around the  
shared X-axis of the two  
modules



360° rotation around  
the X-axis



180° rotation  
around the Y-axis



# Multi-Level Self-Locking Support Legs

Adapts to all terrains, whether it's steps, slopes or potholes.



Integrated dual-axis level, easy to find the balance point



# Unique Coaxial 3-Wheel Design

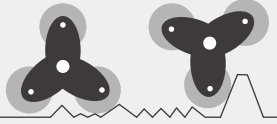

One-person can transport onto any terrain



Special slots are compatible with small warning lights.



A handle that provides the best grip doubles as lift point.



Climbs heights without a forklift if necessary.



Stays stable on muddy ground with maximum contact surface.

Wading depth up to 10cm refers to the water line mark on the light tower body.

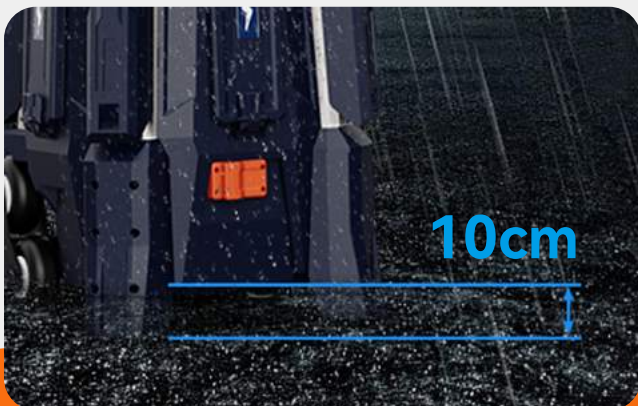

# Humanised Design Hidden In The Details

## Handheld controller

With spring wire, no need to bend over to operate.

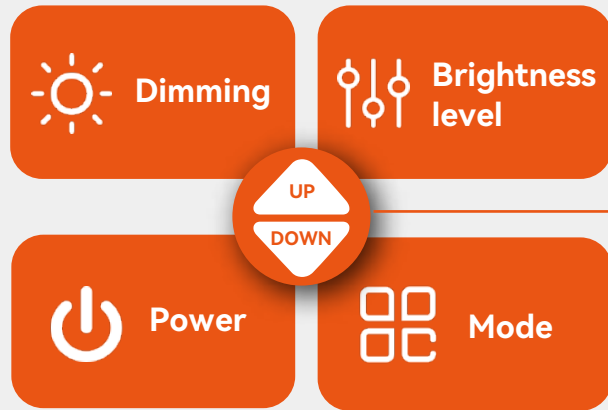

## Multifunctional storage space design



Equipped with multiple interfaces to charge devices

Waterproof toolbox

## Didn't change the battery in time? Don't worry.

Disengage the clutch, then manually retract the pole.





# Ultra-Long Working Hours



**D24-500 (3Kg)**

Portable lithium battery with large capacity in a small size



**10 - 100** Hours  
Turbo Mode    Eco Mode

With 3 fully charged batteries, it can provide 10-100 hours of light



**X3**

AC driver for direct power connection.



# High-Efficiency LED Light Source

Free switching of multiple angles.

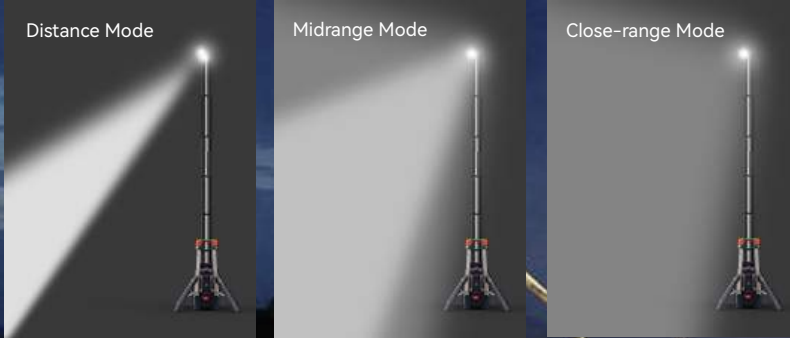

**4.2M**  
Battery-powered  
Up To **33,000LM**

**5.3M**  
Battery-powered  
Up To **35,000LM**

## 4 Levels of Brightness (Battery Powered)

	Eco	Balanced	Standard	Turbo
<b>5.3M</b>	3,000LM	10,000LM	18,000LM	35,000LM
<b>4.2M</b>	2,800LM	9,500LM	17,000LM	33,000LM

The brightness and battery level can be viewed on the controller when using batteries.



**4.2M**  
AC Powered  
Up To **62,000LM**

**5.3M**  
AC Powered  
Up To **65,000LM**

## Stepless Dimmable (AC Powered)

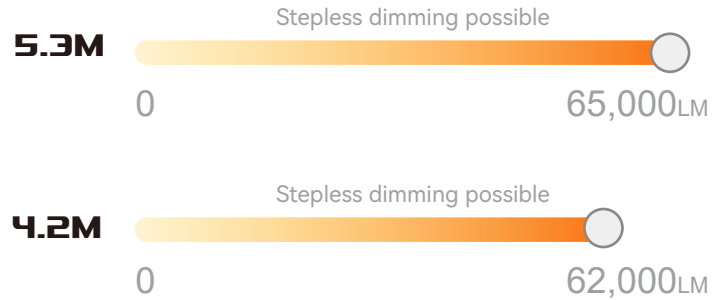

When AC powered, knob on driver controls 0-100% dimming.



# Optional Accessories

A variety of accessories are available to expand the power supply options.



Charger (MC-2H)



Battery (D24-500)



Driver - AC100-277V Input (X5-320)



TKC-9H

FS8-200

9 Bay Charger Case (3xD24-500 Available)  
+ Solar Panel



# One-Person Operation

One operator can transport, deploy and adjust lighting.



Construction



Mining



Emergency



Sport



Firefighting



Event

**Total light tower weight is**  
(excluding battery pack).

**50 kg** (4.2m) **52 kg** (5.3m)

For quick deployment in emergencies this equipment fits easily into standard SUVs for single-person loading. ★



★ Proper securing and part locking are crucial during transport. Two or more people are required for lifting unless a forklift is available.

# Parameter

## LXTL5000 4.2m

Height	4.2m
Weight	50Kg (Fitting only)
Power Supply	Battery / AC 100-277V
Lumens	Battery 0-33,000LM / AC 0-62,000LM
Run Times	>20h (Standard mode, D24-500 x 3)
IP Grade	IP65
Output(USB)	Type-A (5V 2A) & Type-C (5V 2A)
Battery System	D24 Series

## LXTL5000 5.3m

Height	5.3m
Weight	52Kg (Fitting only)
Power Supply	Battery / AC 100-277V
Lumens	Battery 0-35,000LM / AC 0-65,000LM
Run Times	>20h (Standard mode, D24-500 x 3)
IP Grade	IP65
Output(USB)	Type-A (5V 2A) & Type-C (5V 2A)
Battery System	D24 Series

## Size (cm)

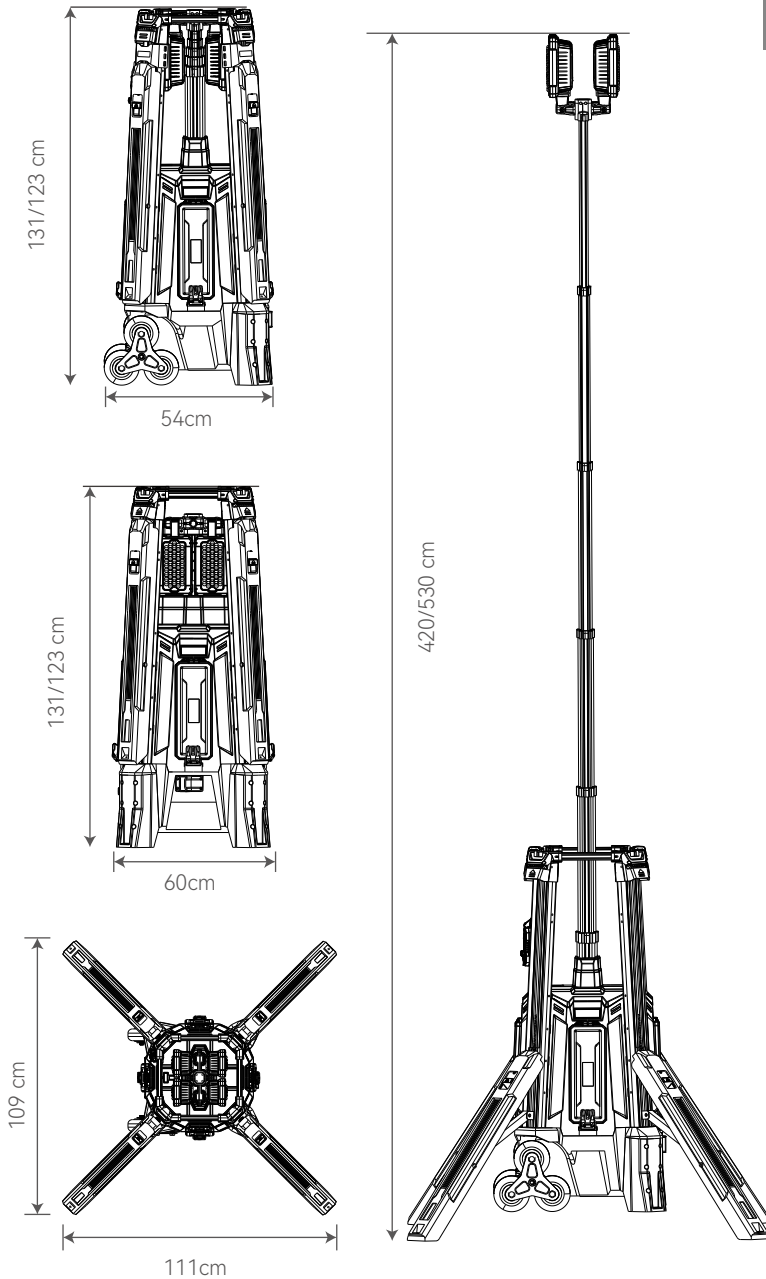

## Package

Model	Size of Carton	Gross Weight of Carton	PCS/Carton
LXTL5000 4.2m	640*640*1365mm	63Kg	1
LXTL5000 5.3m	640*640*1435mm	65Kg	1

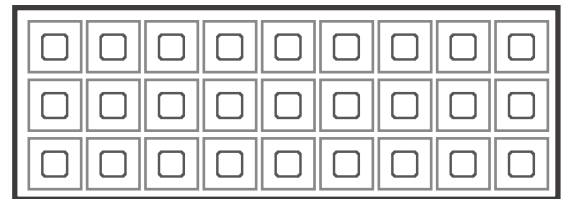
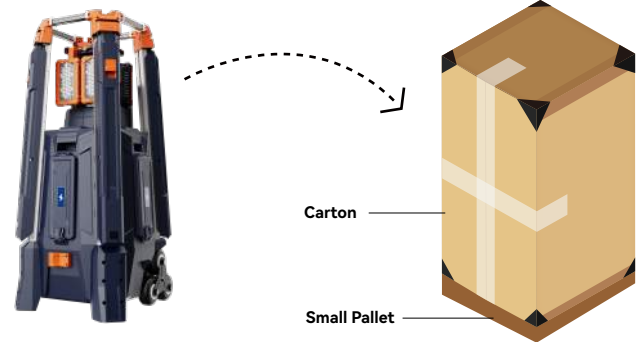

**20GP Container 27 Unit**

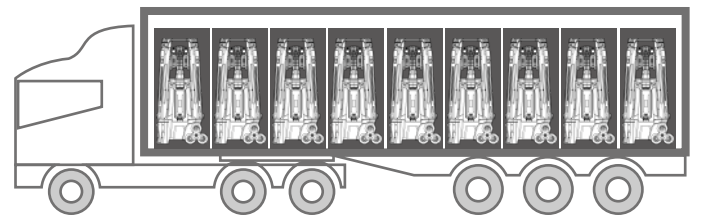

**40GP Container 54 Unit**